



DOCUMENTATION SHEET

Anti-vibration Mountings Type MP 4

MP 4

General

The MP-mountings (Multi Purpose) are developed to offer excellent passive and active vibration isolation for various applications. Next to offering excellent isolation the MP-mountings internal deflection limiter avoids overload and allows use for mobile applications on for example trucks and on board of ships. The geometry of the metal top offers protection to the natural rubber against oil and ozone.

Typical applications:

- Generators
- Engines
- Fans
- AC-units
- Cooling equipment
- Electro motors
- Cabinets

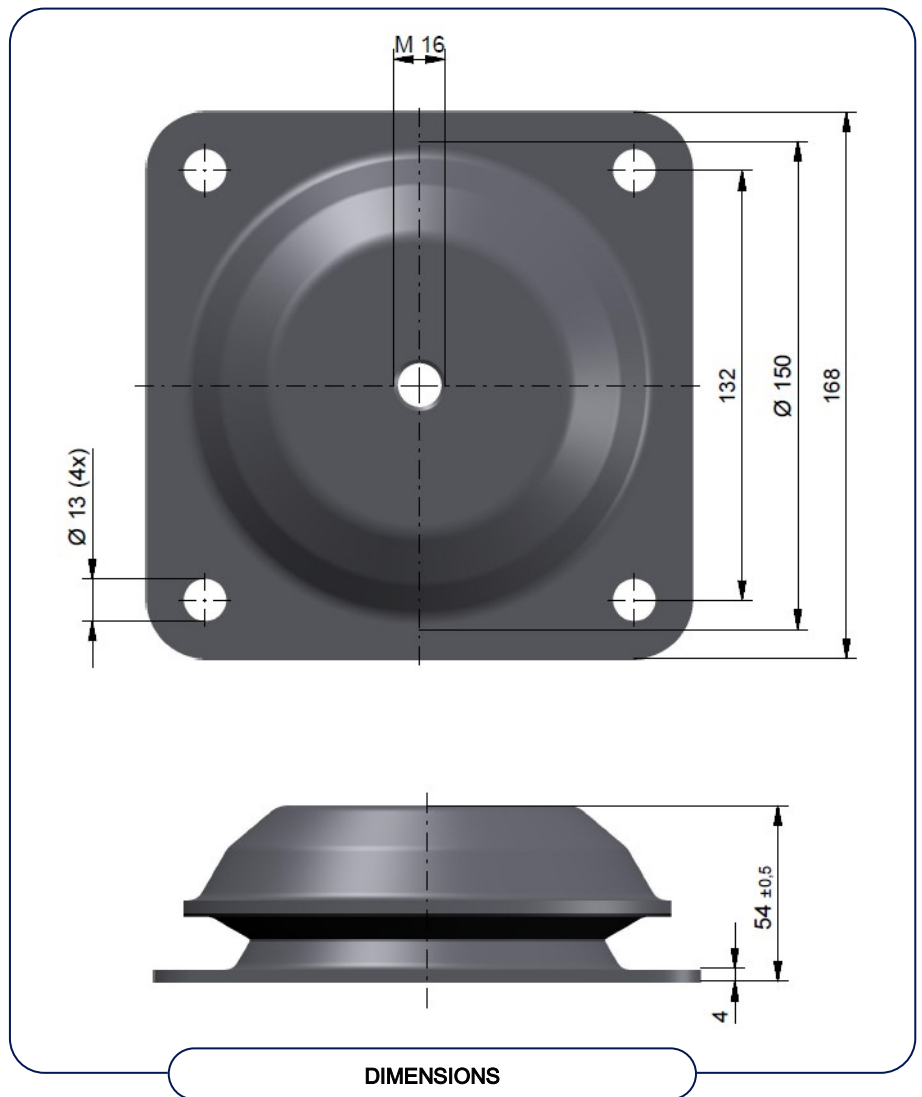



Type	Max. load marine (kN)	Max. load static (kN)	Max. vert. defl. marine (mm)	Max. vert. defl. static (mm)	Cz stiffness (N/mm)
MP4-45	7.2	8.4	5.3	5.9	1350
MP4-55	8.4	10.9	5.0	5.6	1780
MP4-65	12.4	14.5	4.8	5.3	2650

CHARACTERISTICS

Vertical load / deflection characteristics
Type MP-4

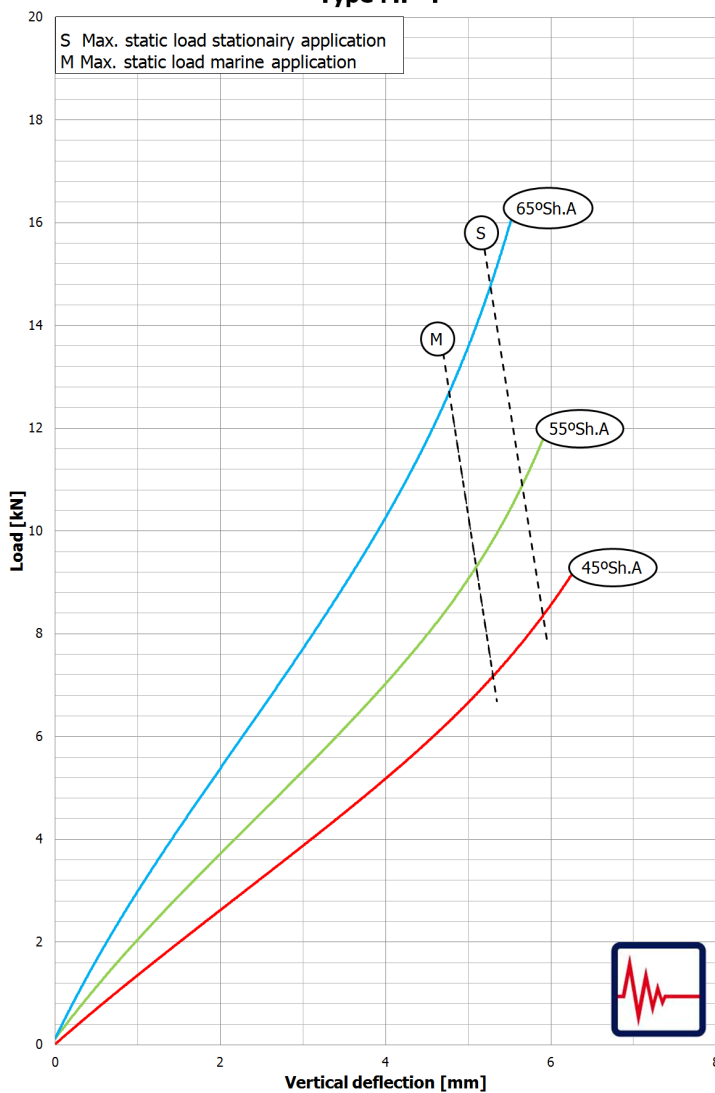

SELECTION CURVE



TYPE APPROVALS

Rubber Design B.V.

Industrieweg 21

2995BE Heerjansdam

The Netherlands

Phone: +31 (0)78 677 87 78

Fax: +31 (0) 78 677 10 38

Email: info@rubberdesign.nl

Web: www.rubberdesign.nl